

SIDE FOLDING Prestige Wide Body

General

Summary

- A Style:** Manual side-folding polycarbonate and aluminium concertina door.
- B Lock Cylinders:** Standard Keyed Mortise Cylinders
Custom Cylinders: All cylinders provided by customer must be delivered to Dynamic prior to manufacturing for fitting to door to ensure Warranty Condition.
- C Site preparation:** Track support, storage pockets/cupboards and other miscellaneous structural or finish work is the responsibility of others.

Submittals

- A By Others:**
 - 1 Shop Drawings: Include plans, elevations, required clearances and accessories.
 - 2 Site Requirements including inductions and access
 - 3 Installation Instructions: If Required.
- B Manufacturer and Installer Qualifications:** If Required.
- C Installation Certificates.**

Quality Assurance

- A Manufacturer Qualifications:** Minimum of three years experience in the fabrication and installation of Side Folding Security Door.
- B Installer Qualifications:** Authorized representative of the manufacturer.
- C Pre-installation Conference:** A Dynamic Representative will contact the provided Site Foreman/Contact just prior to commencement of field operations to establish procedures to maintain optimum working conditions and to coordinate this work with related and adjacent work.

Warranty

- A Limited Warranty:** Two year from the time of installation for defective materials and workmanship.

Execution

Examination

- A** Examine supports and other conditions under which Doors are to be installed.
- B** Coordinate with responsible entity to correct unsatisfactory conditions and do not proceed with installation until conditions are corrected.

Installation

Follow manufacturer's installation instructions and approved shop drawings.

Adjusting

Test operation of Door and adjust as necessary to provide smooth and proper operation.

Demonstration

Instruct Owner's personnel in proper operating and maintenance procedures.

Some technical pages are under development. For any further queries please contact our specialists on **FREECALL 1800 396 264**



Products

Models & Materials

- A Model:** PRESTIGE WIDE BODY
- B Curtain:** 285mm O/A wide x 101mm high truss-like aluminium panels top and bottom of curtain with 240mm wide clear polycarbonate infills with each individual panel encapsulated top and bottom with a vinyl retainer. **Maximum Height 5000mm.**
- C Curtain Edges:** 32mm x 53mm extruded vertical members, with top and bottom automatically retractable locking posts. One intermediate member shall be provided for every 3000mm of opening. All intermediate members shall be fitted with adjustable, concealed drop bolts. Intermediate member spacing on counter applications 1800mm max.
- D Locking:** Lead posts shall be provided with cylinder locks and guards, operable from both sides. Master keyed cylinders (if required, shall be supplied by others). Dust resistant floor sockets shall be provided.
- E Finish:** Standard finish is clear anodized. Powder coating (Dulux Colour Range) and Anodizing in colours is an optional extra.
- F Track:** Extruded aluminium 38mm high x 36mm wide. Curved tracks (where required) are supplied with a standard radius. To provide smooth and easy operation for custom curved applications, the radius must be nominated (minimum 1500mm). For elliptical curves, a template must be provided to Dynamic Closures (Aust) Pty Ltd prior to manufacture. **Standard Radius Curves Available.**
- G Operation:** Manual pull – push operation.
- H Optional Extras:** Egress Doors for emergency exits. Tapered openings.



SIDE FOLDING

Prestige
Wide Body

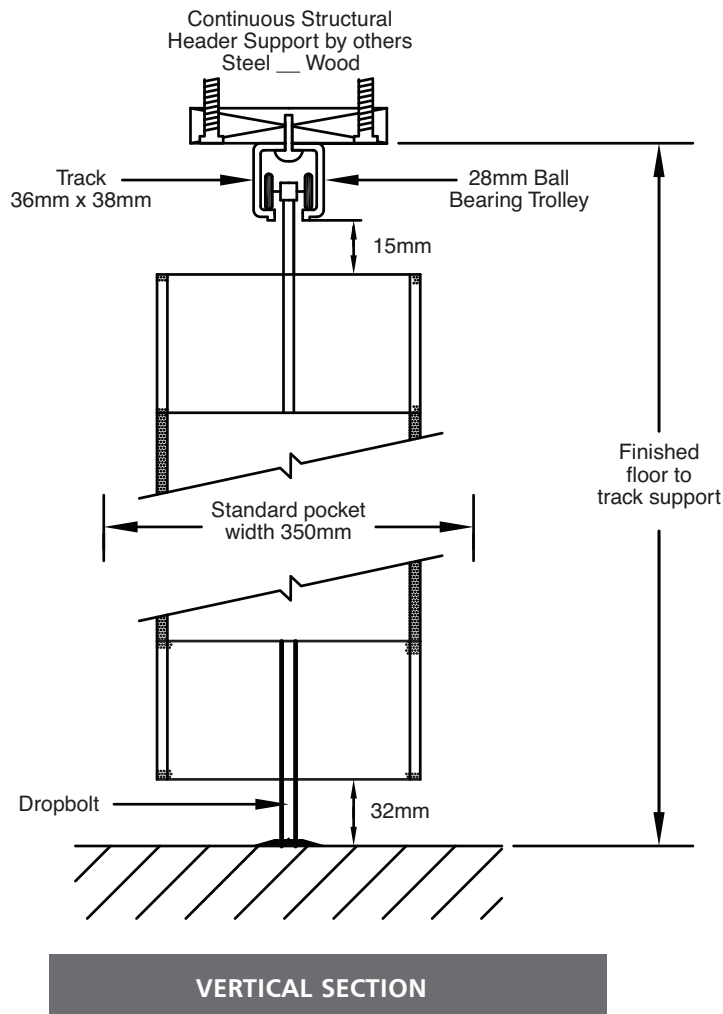

Avant Garde
Grille

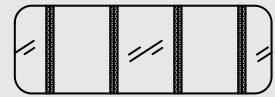

Futura
Tempered Glass Inserts

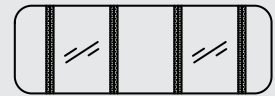

Prestige
Polycarbonate Inserts

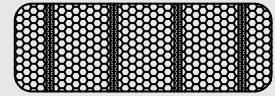

Paravent
Perforated Aluminium Inserts

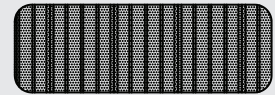

Opaque
Solid Aluminium Inserts

FIXED INTERIOR

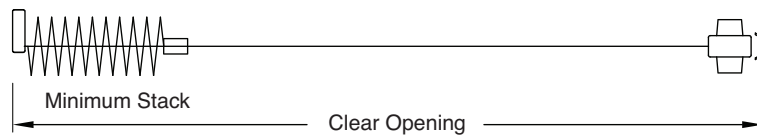

STRAIGHT INTERIOR

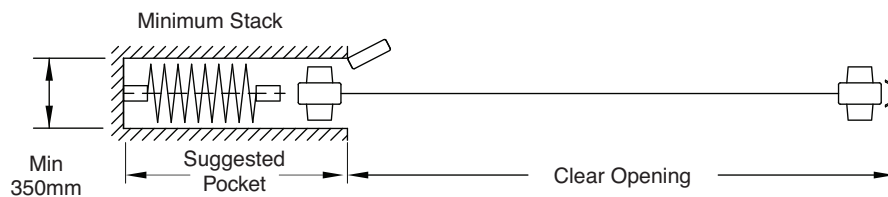

BI-PARTING INTERIOR

